

Pump Model CPS 150-100-250

Speed 2900rpm

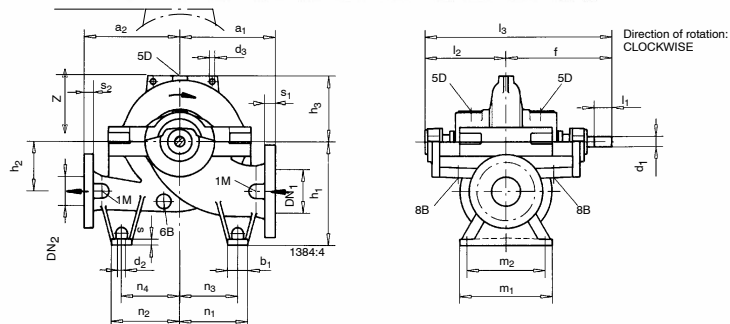
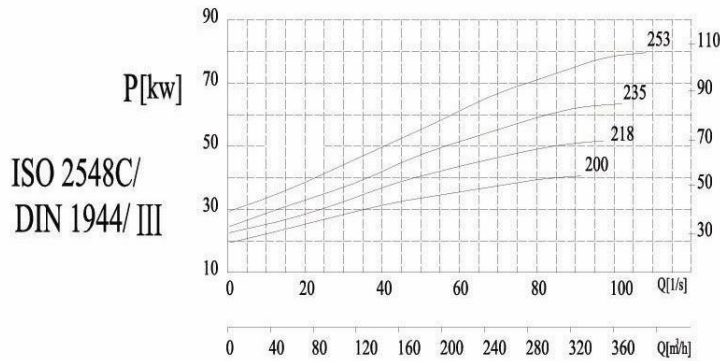
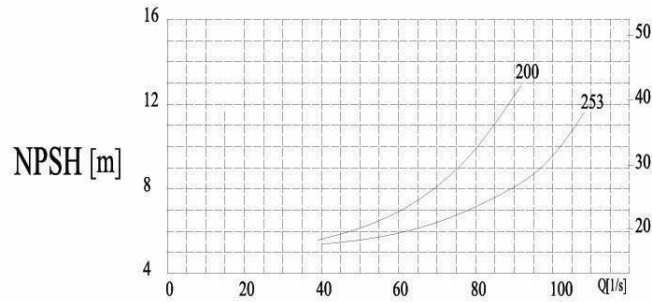
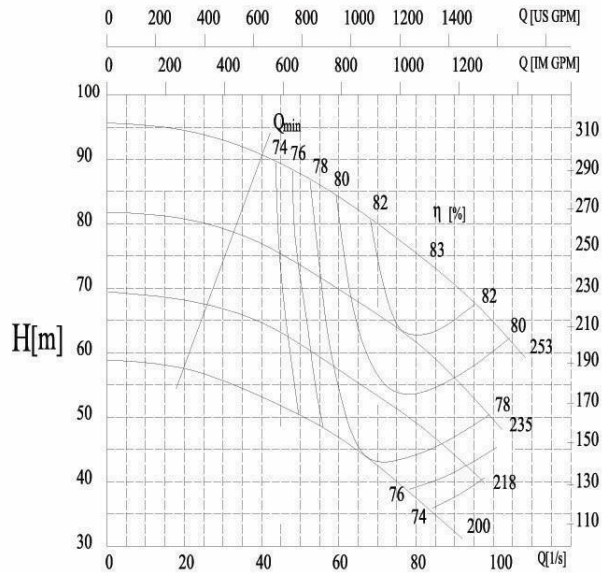

Pump Size	FLANGE DIMENSIONS				PUMP DIMENSIONS									
	DN1	DN2	s1	s2	a1	a2	d3	f	h1	h2	h3	l2	l3	z
CPS 150-100-250	150	100	37	32	330	330	19	415	355	170	195	300	715	390
	FOOT DIMENSIONS								SHAFT		PUMP WEIGHT			
	b1	d2	m1	m2	n1	n2	n3	n4	s	d1	L1	(kg)		
70	18	320	270	235	235	200	200	20	35	80	210			